

PALAZZANI XTJ 52 +

Working ranges

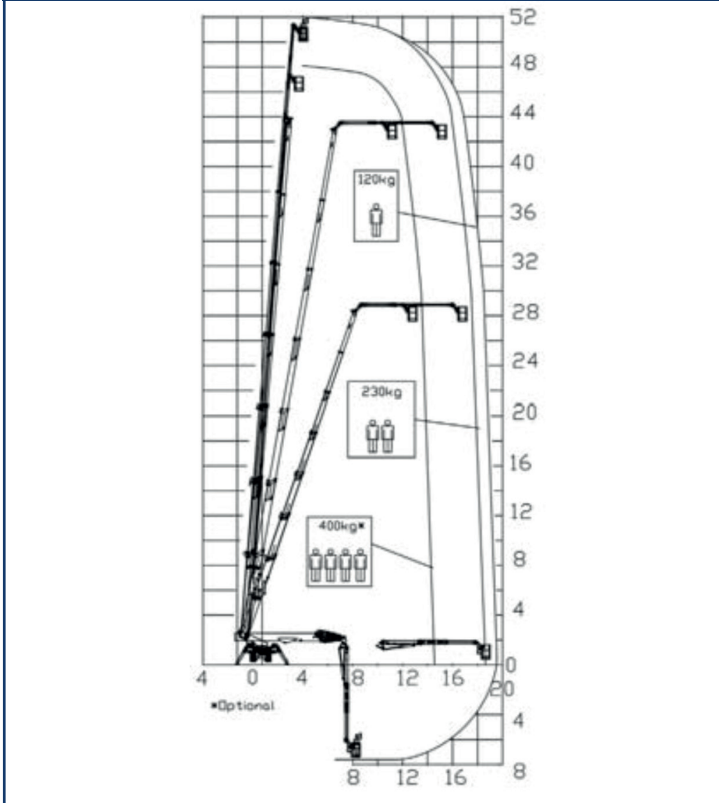

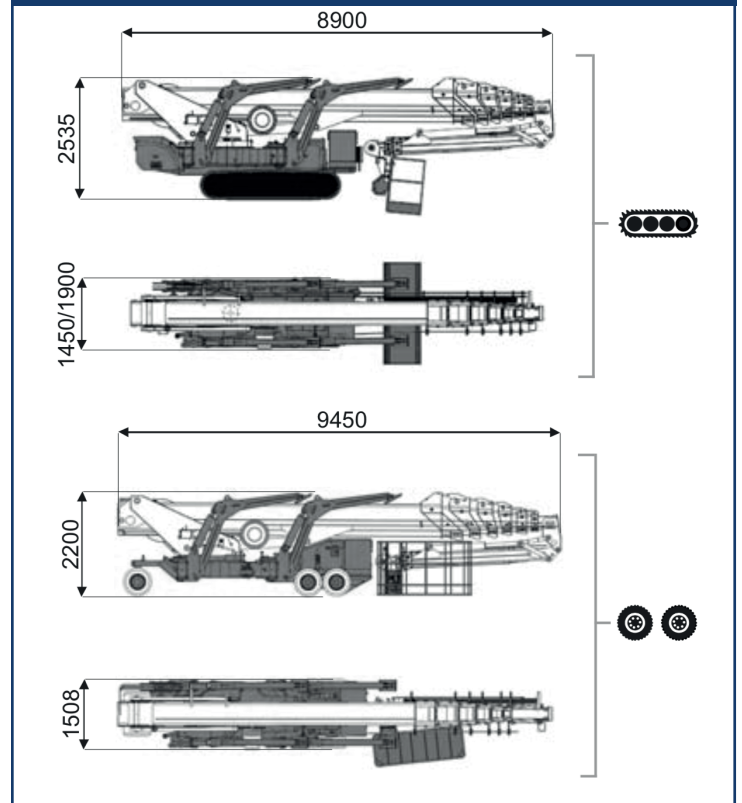





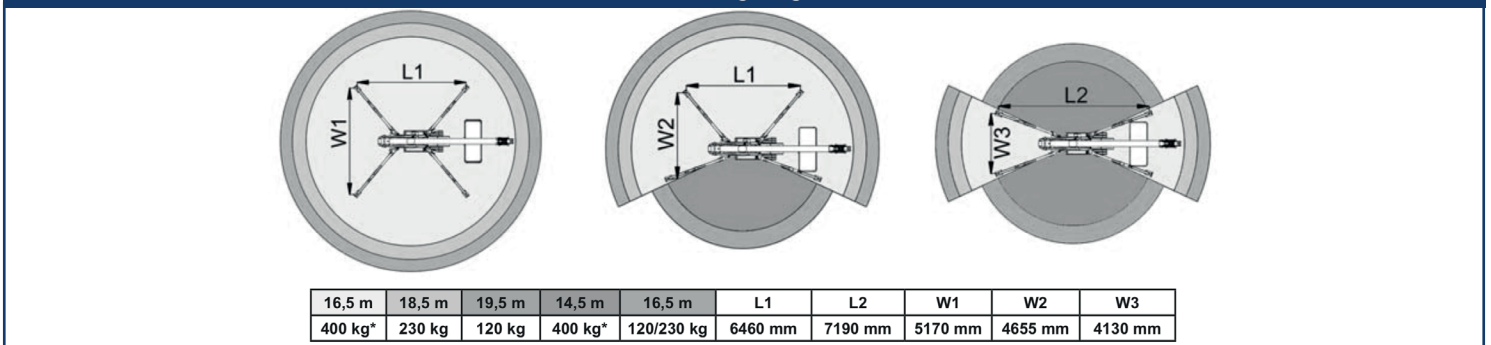











Dimensions



Working ranges



Specifications

BI-ENERGY Diesel+AC																
XTJ 52*/C 	52 m	19,5 m	400 kg*	170°	660°	240x70 cm	90°+80°	4,13-5,17 m	16%	42%	2 km/h	14000 kg	95 kN	4,19 kN/m ²	6,56 kN/m ²	
XTJ 52*/R 	52 m	19,5 m	400 kg*	170°	660°	240x70 cm	90°+80°	4,13-5,17 m	16%	16%	1,2 km/h	13000 kg	95 kN	3,89 kN/m ²	5,73 kN/m ²	