

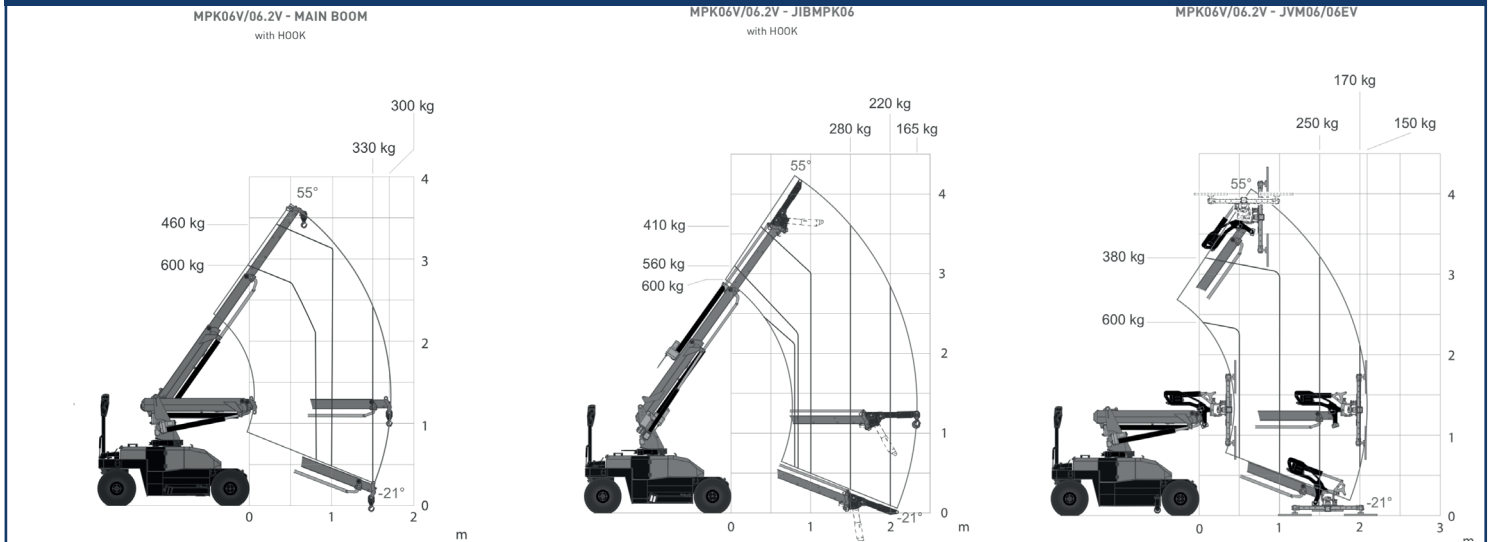













JEKKO MPK06V

Working ranges



Specifications

		Specifications	
ELECTRIC	 Battery	2x 12V 155Ah	
	kW Power	24V DC 3,0kW 4HP	
	 Travel Speed	km/h	3,6
MOVEMENTS	 Gradeability	13° (23%)	
	 Back Wheel Force	kg	265
	 Front Wheel Force		750
	 Working Angle	-21° / 55°	
	 Slewing	-10° / 10°	
		s	1,6
 Boom Telescoping	m	1,2 - 2,8	
	s	37	
ATTACHMENTS		Name/ version	kg
	 Jib	JIB-MPK06	18
	 Manipulator	JVM06	80
	 Manipulator	JVM06EV	110
MPK06V	 Minipicker	MPK06V	709
	 Counterweight	CW1 (into frame)	40
		CW2 (into hood)	151
		TOTAL	900

Dimensions

